

INSTALLATION, USER'S AND MAINTENANCE HANDBOOK

Presentation 2

IMPORTANT INFORMATION REGARDING SAFETY

Preparations for installation 4

Important information for the user 4

Fuel used 4

Important instructions before ignition 4

Recommendations for using the stove correctly 5

INSTALLATION 6

Combustion air inlet 7

Flush-fitting installation 8

OPERATION 9

MAINTENANCE 10

Ordinary maintenance 10

Extraordinary maintenance 10

Maintenance of the smoke exhaust duct 11

OPERATING PROBLEMS AND SOLUTIONS 12

Declaration of conformity 15

Guarantee 16

PROGRAMMING INSTRUCTIONS

PRESENTATION

Dear Customer,
We would first of all like to thank you for choosing an ECOWOOD product.

Our ECOWOOD stoves and inserts are the result of experience and technical innovation acquired after years of work in the energy sector.

Our research and innovation activities are aimed at continual improvement of the product in order to offer high quality, to ensure reliability, good performance and comfort, all with impeccable design.



Please read this handbook carefully and follow the instructions and advice meticulously. This will guarantee optimal use of the product and exploit its advantages to the full. You have bought a stove that has been designed to be safe, practical and economically advantageous in terms of the high efficiency it is able to achieve.

Nevertheless, it is important to be well acquainted with the apparatus if it is to be operated as efficiently as possible and in complete safety.

The device must be installed correctly for safety reasons and to ensure proper operation.

The stove should **never** be used by people who do not know how to work it.

Keep children and animals away from the stove when it is in use.

This handbook has been written by the manufacturer and **is an integral part of the product**. The information it contains is intended for the user and for all those who for various reasons contribute to the installation, use and maintenance of the product.

Before commencing installation or using the stove, read the whole of this **user's and installation handbook** carefully and then keep it in a safe place for the whole working life of the stove.

In the following pages you will find all the instructions you need for **installation, operation and maintenance**, as well as a number of safety rules to be followed.



If you have any doubts or uncertainties on how to use the equipment, please get in touch with the Ecowood sales point.

The retailer will be able to supply you with all the necessary information.

This stove operates only and exclusively with pellets (pressed wood sawdust). Top quality pellets without impurities should be used.

In order to obtain a constant flame with a pleasing appearance it is important to use 6 mm diameter pellets that are about 20 mm long, and as regular as possible.

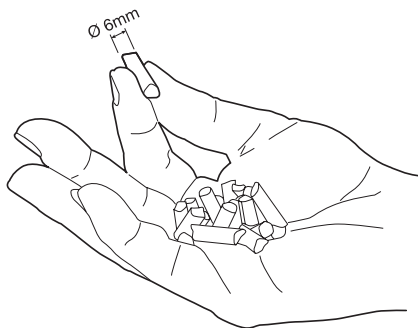

The fumes exhaust piping must be made of Ø 80 mm steel, and have a minimum extension of 3 metres inside the chimney towards the outlet point.

In order to allow residue combustion dust to be periodically removed, use a union tee with a removable cap, which must be blocked in the internal right-hand corner of the flush-fitting stove housing compartment; secure tightly with wall-mounted clamps at the same height or slightly lower than the fumes exhaust point.

Between the flush-fitting stove and the union tee, connect horizontally the SIL 3-360° constant bellows supplied as standard, using the two Ø 100 mm stainless steel screw clamps. The maximum permissible length for the use of the SIL 3-360° bellows is 80 cm.

Connect the combustion air intake of the flush-fitting stove with a Ø 45 mm pipe as far as the outside of the building, in order to guarantee the correct amount of air supply needed for combustion.



STANDARD EQUIPMENT:

- User's and installation handbook.
- SIL 3-360° constant bellows joint.
- Remote control.

OPTIONAL EQUIPMENT:

- Wall smoke flue with quick closure.
- External digital thermostat for the room.
- Room thermostat included in the stove.
- GSM telephone modem (to allow control of the stove from a remote location).

IMPORTANT INFORMATION REGARDING SAFETY

PREPARATIONS FOR INSTALLATION

- In order to prevent the possibility of fire, make sure that the apparatus is installed correctly by carefully following the instructions of this handbook.
- Do not place the stove in rooms where curtains, carpets or other furnishings could burn due to the heat generated by the stove.
- Do not position the stove near curtains, inflammable or combustible material.
- Ensure that the compartment or the chimney where the flush-fitting stove is installed allows an ambient air inlet of not less than 1,5 square decimetres, indispensable for the correct air circulation needed to cool the flush-fitting stove.
- An electric socket for stove connection must be provided inside the chimney; when installing the stove, ensure that it is properly connected to an earth socket by means of the (green-yellow) electric cable.



IMPORTANT INFORMATION FOR THE USER

Fuel used

- This apparatus has been built to burn only 6 mm diameter pellets (pressed wood). It is very important to choose a clean, top-quality pellet without impurities.

For the stove to work properly and safely it is necessary to use pellets that comply with the following standards: DIN 51731 and ONORM-M 7135 (thermal value, residual humidity, diameter, quality of wood used...).

Ecowood cannot assume liability for poor operation of the stove if poor quality pellets are used.

- Use only pellets and **never** put other inflammable or combustible material in the stove.
- Do not use the stove as an incinerator or for any purpose other than that for which it was intended.
- Do not use liquid fuel.
- Keep your stock of pellets at least one metre away from the stove.

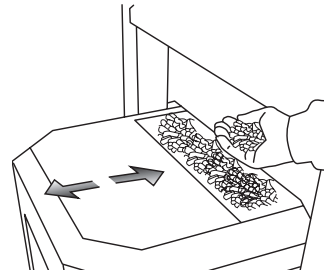

Important instructions before ignition

- Make sure that the fireplace and ash box doors are properly closed.
- Before lighting the stove make sure that all moving parts have been assembled correctly in their respective positions.

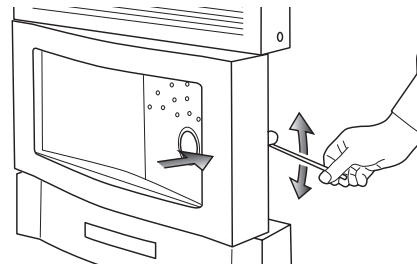

- The gas output system works by negative pressure in the combustion chamber, therefore slight positive pressure is formed in the flue gas exhaust pipe; for this reason it is very important to ensure that the exhaust pipe is free of blockages and fully sealed until it is outside the building.
- To ensure good combustion, make sure that the exhaust pipe and also the combustion air input pipe are clean.
- It must be possible for all stages of the flues to be inspected and removed so that interior cleaning can be carried out.

Recommendations for using the stove correctly

- Make sure that the combustion crucible is always clean; if necessary, remove it when it is cold and clean the holes with a metal scraper, empty the dust from the tray containing the crucible. This operation guarantees a good combustion.
- Clean the combustion chamber every day before lighting the stove and remove any ash residues deposited on the crucible and walls.
- Clean the glass only when it is cold, so as to prevent the risk of burns or scalds, or breakage or cracking of the glass itself.

Use special products for cleaning glass and the body work.

- Take care not to knock against the stove as this could cause permanent damage.
- If the glass is cracked or broken do not attempt to light the stove.
- **Do not open the door of the hearth when the stove is lit.**
- **Always follow these instructions precisely when lighting the stove.**
- **We advise you not to leave the stove unattended while it is operating.**
- **When the stove is not working, you are advised to unplug it from the mains.**
- **Do not perform any unauthorised modifications on the appliance.**
- **Only use spare parts recommended by the manufacturer.**

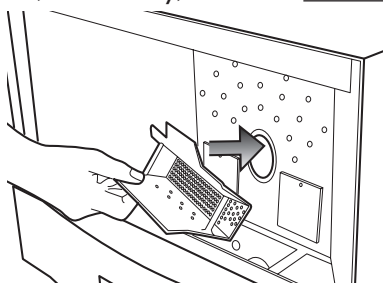

How to proceed when lighting the stove for the first time

For the first few hours of operation the stove will give off an odour caused by stabilisation of the paint and protective grease; to lessen the discomfort, air the rooms well.

Advice

For the first few hours of operation, the gasket on the door of the hearth may stick to the stove. If this happens, remove the seal from the stove, dust it with ash (it acts as an excellent anti-adherent coating) and insert it in its position in the door without using any type of adhesive.

INSTALLATION



The stove must be installed by qualified personnel, who must diligently follow all the rules for correct installation, respecting all the relevant technical, legal and safety standards in force at the time.

When positioning the stove respect the distances shown in the drawing on the right.

Place the stove away from curtains, fabrics, ornaments or anything else that may cause fire.

If the stove is positioned near a wood-lined wall or the gas exhaust pipe is in contact with similar material, insulate the material with suitable fireproof or fire-resistant products.

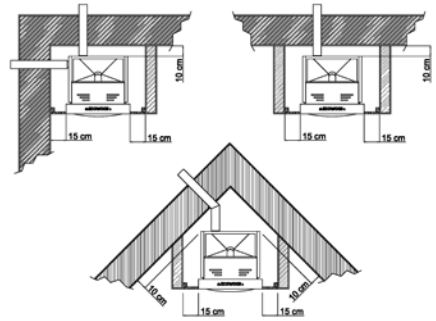

Connect the flue pipe of your stove to an existing chimney or, alternatively, install a fume exhaust pipe outside the building. The pipe must have a minimum pipe diameter of 80 mm and reach higher than the top of the roof.

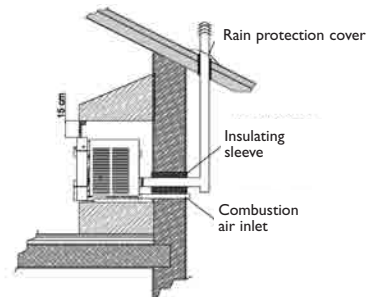

If the stove is installed in a building with potentially inflammable walls, it will be necessary to place an insulating sleeve between the wall and the flue gas exhaust pipe and similarly for the overhanging part of the building's roof.

A T-pipe for inspection should always be installed between the flue gas outlet on the stove and the flue itself.

If the gas exhaust pipe is installed as in the drawing on the right, a rain protection cover will be needed in addition to the requirements listed above.

If the stove is to be installed in an existing chimney flue built into the wall, the pipe should be installed along the whole length of the chimney flue in order to prevent condensation that would mark the walls.

COMBUSTION AIR INLET:

In order to guarantee good combustion, the stove must receive enough air to ensure the fuel receives sufficient oxygen. Connect the combustion air inlet to the outside so that it cannot be obstructed, even partially, in any way.

If the stove cannot be connected directly to the outside, it is possible to install a **permanent ventilation grating**: this will guarantee perfect combustion (and hence lower pellet consumption with less ash accumulating in the hearth), the cooling of the stove and will prevent health risks for those using in the room.

Between the stove and the floor, if the latter could be inflammable, be sure to insert heat protection, ensuring it protrudes at the front and sides by at least 20 cm.

Connect the power supply cable to a 230 volt mains outlet.

Make sure that the body work of the stove is earthed correctly.

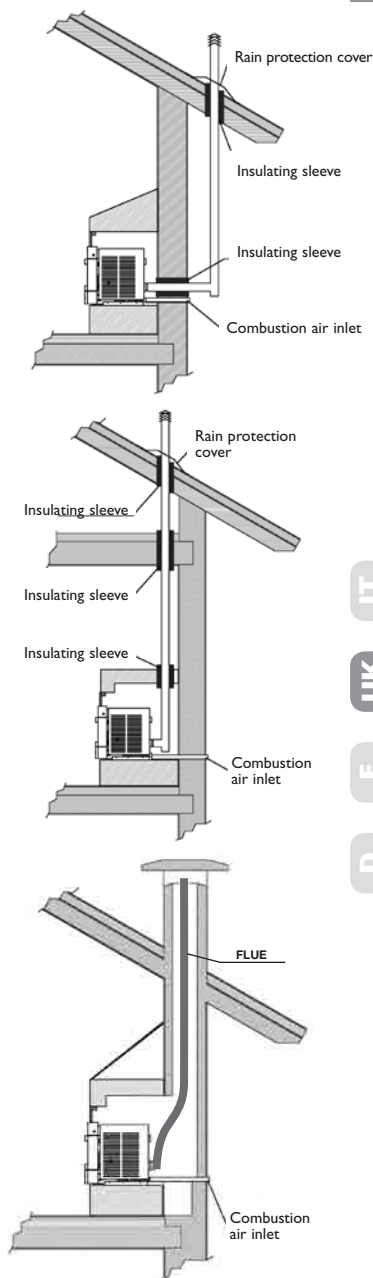

IT
UK
F
D

FLUSH-FITTING INSTALLATION

To install a flush-fitting stove, observe the following guidelines:

- Flush-fitting stove installation must be carried out by qualified technical personnel.
- Fit the sliding steel guides to the bottom of the flush-fitting stove.
- Fix the metal plate (flush-fitting kit) in the chimney or chimney liner onto a solid support base, using materials able to guarantee adequate safety in supporting the full-load weight of the stove, when this is operated for pellet loading.
- Between the flush-fitting stove and the union tee, connect horizontally the SIL 3-360° constant bellows supplied as standard, using the two Ø100-mm stainless steel screw clamps. The maximum permissible length for the use of the SIL 3-360° bellows is 80 cm.
- Connect the combustion air intake to the outside.
- Ensure that the compartment or the chimney where the flush-fitting stove is installed allows an ambient air inlet of not less than 1.5 square decimetres, indispensable for the correct air circulation needed to cool the flush-fitting stove.
- To fill any spaces between the flush-fitting stove and the chimney liner, use the standard fire-retardant filling panel supplied by ECOWOOD. Other materials can also be used, provided they are fire-retardant, making sure that the filling panel can be easily removed, in order to allow comfortable access for periodical maintenance and any technical assistance required for the flush-fitting stove.
- It is advisable to load the combustible pellets while the stove is switched off.

NOTE: it is possible to change the direction of the flue gas outlet, (standard, on the back inside the stove) so that the outlet can be on the left side, looking at the stove from the front.

To take advantage of this possibility it is necessary to disassemble and turn the flue exhauster motor screw through 90°, tighten the screws in the new position and make an 90 mm hole on the desired side.

This modification must be done only and exclusively by the installer.

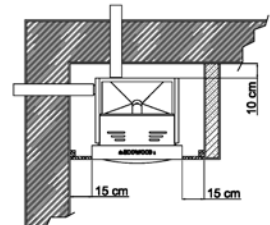

SAFETY

Constantly check the integrity of the exhaust gas bellows; should this show any cracks or other signs of deterioration, proceed to replace it immediately. The bellows must also be replaced in the case where smoke can be smelt during normal stove operation.

The expected average life of the SIL 3-360° bellows is approximately two years, if carefully used and looked after. It must be replaced after two years of operation at the latest.

OPERATION

- After installing the stove as described above, fill the tank on top of the stove with the pellets through the door on the stove. The tank should always contain enough fuel to guarantee a regular supply to the stove and the door should be closed during operation.
- Make sure that the crucible is correctly inserted into the tray.
If the crucible is not inserted properly or is very dirty it may cause poor combustion or the fire may not ignite.
- Make sure that the hearth door and the ash collection drawer are closed properly so that smoke does not escape, moreover, excessive air infiltration will increase smoke production and deposit more dirt in the hearth and on the glass.
- During the ignition stage (25 minutes), the pellet loading rate is that setted by the manufacturer and cannot be changed.
- The hot air fan comes on automatically about 15 minutes after ignition, at the first speed, and levels itself at the selected power for the normal operating cycle, 25 minutes after ignition.
- It is possible to adjust the hot air fan separately from fuel loading rate (only for the first two power levels); the two functions are currently set proportionately by the manufacturer.
- To switch off the stove completely just press the **ON/OFF** button again; after the flame has gone out the stove will remain in operation for about 25 minutes until all the internal parts have cooled down.

IMPORTANT

Continuous operation of the stove at maximum power could shorten the life of the electronic and mechanical components, and also reduce safety.

The stove is able to operate continuously for long periods of 10÷15 hours if the selected pellet loading power level does not exceed the third position.

Using the stove at the fourth or fifth loading rate for long periods will reduce safety, therefore an automatic power limiting device has been installed as standard in the stove.

If the automatic power limiting device is disabled at the user's request (this should be done by the installer technician following an evaluation of the conditions under which the stove is to be used), it is necessary to connect the stove to the flue gas exhaust system using stainless steel pipes, or pipes painted with airtight seals. If the fourth power level is selected we advise operating the stove continuously at this level only if it is alternated hourly with operation at lower load rates, while the fifth level should only be used continuously for a maximum of 30 minutes.

REAR AIR DISCHARGE FUNCTION (FI3 Dual - FI5 Dual)

To use rear air discharge, take into account the following recommendations: when the stove is used with a closed butterfly valve, the power selector should **not be set higher than third speed** to avoid overheating, causing the heat safety switch to activate. The switch can be found to the right, at the rear inside the stove. If this happens, the user must wait until the stove cools down to a temperature less than 93°C so as to be able to reactivate and ignite the stove again.

MAINTENANCE



Warning! Before carrying any maintenance, disconnect the power supply and wait for the stove to cool down completely.

ORDINARY MAINTENANCE:

Weekly, by the user

- Check the hearth and clean the holes if necessary, making sure that all the holes are open.
- Clean any ash residues from the hearth holder, from the combustion air pipe and from the ignition resistance.
- Take out the flame breaker plate situated in the upper part of the fireplace and remove any ash deposited.
- Open the heat exchanger by turning the two inspection air vents and vacuum out any dust.
- Clean the combustion chamber and the glass with non-abrasive products.

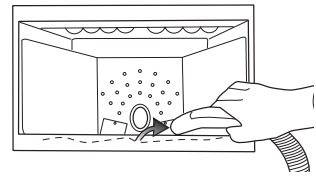
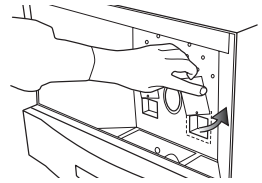

EXTRAORDINARY MAINTENANCE:

every 2500 working hours, this must be done by a professional technician

- Check the integrity of the exhaust gas bellows

Front cleaning:

- Remove the perforated combustion hearth and the hearth holder.
- Remove the screw that locks the bottom plate and extract the plate by pushing it upwards.
- Remove the other four screws and extract the panel giving access to the horizontal tubes.
- Carefully vacuum clean the tube bands from dust deposited in the heat exchanger.

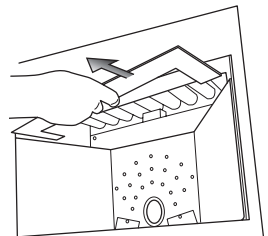

Rear cleaning:

- Open the door on the left side of the stove and clean internally all discharge ducts (manifold, fan scroll, smoke evacuator blades).
- Carry out general cleaning of all parts in between the two doors, and reassemble all parts in an inverse sequence.
- Re-assemble all the parts in the reverse order, oiling the screws.
- After carefully carrying out all necessary checks, the automatic stove operation blocking device should be reset so that the stove will operate for a further 2500 hours.

The advice about regular cleaning and maintenance is only indicative and may vary according to the quality of the pellets used in the stove, therefore whenever you note worsening combustion or increased dirt on the fireplace and glass surface this cleaning should be carried out in any case.



We recommend taking out an annual maintenance contract with the place where you bought the stove. In this way you will be able to programme cleaning of the stove at the end of the season, keep it in working order and ensure it is ready to operate properly the following season.



WARNING

Installation and extraordinary maintenance must be done only by skilled, technical personnel.

- **IMPORTANT NOTE:** if the stove is connected to the outside by a metal flue gas exhaust pipe, two conditions could be deleterious to good combustion.
 - 1- If the horizontal part of the flue gas exhaust pipe is too long, this will worsen the quality of combustion and noticeably increase ash residues in the grate. For this reason the electronics board has a facility for regulating both the exhaust pressure and pellet loading rate. This should be carried out only by the installer technician, at installation or when conditions make it necessary.
 - 2- A vertical metal exhaust pipe that is three / four metres long will increase the combustion rate. This will cause the stove to go out at the minimum power level. To prevent this just increase the selected power level or change the original settings.

MAINTENANCE OF THE SMOKE EXHAUST DUCT

- Annually, we recommend cleaning the smoke exhaust duct in order to prevent self-combustion of any soot and powder that may be deposited there.
- In case of fire switch off the stove immediately and disconnect it from the power supply.

OPERATING PROBLEMS AND SOLUTIONS



Warning! Only skilled technical personnel are allowed to dismantle the stove and work on the internal components.



Before carrying out any operation whatsoever, disconnect the power supply and wait until the stove has completely cooled down.



1. If the stove does not ignite, make sure that:

- It is connected to the electricity supply.
- The crucible is inserted into its holder.
- The ash collection box is inserted into its holder.
- The door of the hearth is closed.
- Pellets arrive in the crucible; make sure the tank contains sufficient fuel for the stove to operate. If the pellet supply finishes during use, the stove will switch off by itself.
- The thermal safety switch is activated; otherwise disconnect the power supply, reset the switch by pressing the button on the switch itself, then restore the power supply.
- The combustion air pipe is completely open.
- The exhaust gas flue allows the fumes to escape. If not this would fail to generate the necessary negative pressure and the vacuum pressure switch would interrupt the power supply to the pellet loading motor.
- The flue exhauster motor works properly. If it is not working, make sure that it is powered; if there is power and it turns slowly, replace it with a new one (if the flue exhauster motor stops, the electronic board will immediately stop to feeding the pellet).
- The screw motor is working properly.
If it is not working, make sure that it is powered; if there is power and it does not turn, replace it with a new one (if the motor reducer stops, the stove will use up the fuel in the crucible and then go out completely).
- The hot air fan is working properly. If it is not working, make sure that it is powered; if there is power and it does not turn, replace it with a new one (if for any reason the fan does not work, the stove will stop automatically, to avoid overheating by activating the temperature cutout).
- The resistance is red-hot.
If it is not working, make sure that it is powered; if there is power and it does not heat up, replace it with a new one.
- The pellet feed screw is not obstructed by a foreign body (remove fuel from tank)
- The vacuum pressure switch has not been blocked by poor combustion or an obstruction in the exhaust pipe (re-activate it by blowing and sucking until you hear the switch come into operation).
- Check whether the stove is ready for programmed cleaning after 2500 hours have expired. The display will show **Cleaning/Maintenance** message.

If the problem persists, consult your retailer.

2. If the stove goes out during operation:

- Check all the possibilities in previous section.
- Check whether the stove is ready for programmed cleaning after 2500 hours have expired. The display will show **Cleaning/Maintenance** message.
- Make sure that the thermal safety switch (re-settable manually), on the inside back right of the stove, has been reset.
- Before resetting the switch find the reason for its triggering.

Note that the thermal switch can only be reset with electrical supply off and when the stove temperature has fallen below 93°C.

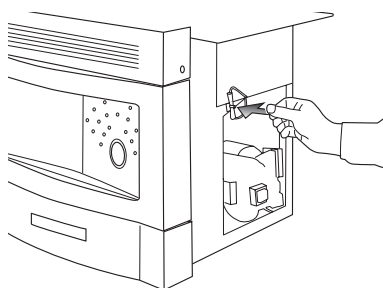

POWER FAILURE

Brief power failure: if there is a brief power failure (60 seconds), when the stove is at the ignition stage or is operating normally, the stove is programmed to re-ignite itself. If the power failure lasts for a longer, indefinite period, when the power returns the stove will go into an extinguishing cycle, setting up for the next (manual or programmed) ignition. In this case the display will show **Black-Out** message.

To reset the stove functions, switch it **ON-OFF**.

Temporary power failure: If there is a power failure lasting 3÷5 minutes, with direct flue gas exhaust pipes the stove may emit some smoke into the room, produced by the unburnt pellets present in the grate.

This does not constitute a safety risk. The problem can be avoided by installing the exhaust pipe as shown on this handbook.

Electrical safety: the stove is protected against power surges by two fuses on the electronics board.

ANNEX: ALARM AND NOTIFICATION

All alarm and notification messages appear on the display, possible causes and solutions.



Clock not programmed

Problem: The time and date has not been set. The timers cannot be used.

Solution: Set the time and date and any timers in the respective menu.



Maintenance request for cleaning

Problem: There are 100 operating hours left from the time of the message appearing before the stove will be blocked for cleaning.

Solution: Arrange for a technician to clean the stove.



Sudden power cutout

Problem: The power has been down for more than a minute. The stove signals the power cutout and shuts down.

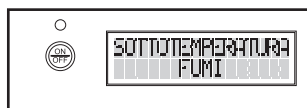

Alarm: gases not up to heat

Problem: The discharge gases have become too cold; the embers have gone out.

Cause: The pellets in the tank are finished. Refill the tank.



Alarm: start-up failed

Problem: The stove has not started up.

Cause: The brazier is dirty or not properly in place. No pellets. The element does not work. CONTACT THE TECHNICIAN.



Vacuometer alarm

Problem: Trouble discharging the gases.

Cause: The flue system is obstructed. CONTACT THE TECHNICIAN.

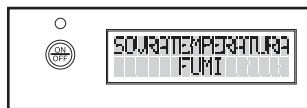

Alarm: overheating gas

Problem: The temperature of the discharge gases has exceeded the permitted threshold.

Cause: The gear motor is operating continuously, the gas probe is broken. CONTACT THE TECHNICIAN

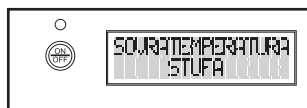

Alarm: stove overheating

Problem: The body of the stove has exceeded the permitted threshold and is overheating.

Solution: The fan is not cooling down the stove. CONTACT THE TECHNICIAN.

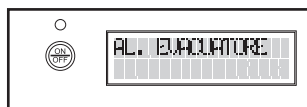

Alarm: gas evacuator motor

Problem: The gas evacuator motor is not working or the board cannot detect its operation.

Cause: The motor is not powered or the tachometer sensor is not responding. CONTACT THE TECHNICIAN

DECLARATION OF CONFORMITY



According to the Directive **89/106/EEC** (Construction Products), the CE Regulation **1935/2004** (Materials and Articles intended come into contact with foodstuffs), the Directive **2006/95/EEC** (Low Voltage) and the Directive **2004/108/EEC** (Electromagnetic Compatibility).

Type of equipment: Appliance for domestic heating that uses wood pellets.

Trademark: **ECOWOOD**

Type designation: FI 2 - FI 3 DUAL - FI 4 - FI 5 DUAL

Use: Domestic heating

Manufacturer: ECOWOOD **Address:** Via Borgo, 36 - 36034 Malo (VI) **Tel./ fax:** 0445 580725 / 0445 602079

Notified laboratory: IMQ primacontrol S.R.L.

The following harmonised standards or technical specifications (designations) which comply with good engineering practice in safety matters in force within the EEC have been applied:

EN 14785 • EN 60335.1 • EN 55014.1 • EN 55014.2 • EN 50165 • EN 61000-3-2 • EN 61000-3-3

Test report / Technical file: **08-LC-03 S.1**

As the manufacturer's authorised representative established within the EEC, we declare on our sole responsibility that the equipment follows the provisions of the Directives stated above.

Date and place of issue: _____

(Name and signature of authorised person: _____)

(Position in firm) _____

		Potenza termica nominale : 10 kW
		Potenza termica ridotta : 3,5 kW
		CO misurato (al 13% di ossigeno) nominale : 0,020 % ridotta : 0,040 %
Mod: ECOWOOD FW1 FWM FI2 FI3 FI4 FI5		Rendimento nominale : 79,35 % ridotta : 78,88 %
EN 14785: 2006		Potenza elettrica max. assorbita in fase di accensione : 340 W
	Distanza minima da materiali infiammabili R = 200 mm L = 200 mm B = 200 mm	Potenza elettrica nominale : 120 W
		Tensione nominale : 230 V
		Frequenza nominale : 50 Hz
		Leggere e seguire le istruzioni d'uso
		Usare solo i combustibili raccomandati

Questo apparecchio può essere usato su canna condivisa

IT

UK

F

D

GUARANTEE

The guarantee constitutes part of the general conditions of sale and is regulated by EC directives 1999/44, and Italian Legislative Decree 24 of 02/02/2002.

By guarantee we mean replacement or repair without charge of parts acknowledged to be originally defective due to manufacturing defects. The product is guaranteed for two years.

The guarantee is valid under the following conditions:

- The stove has been installed by an authorised installer technician who has completed the guarantee form after carrying out final testing.
- The apparatus is used as required in the instruction handbook.
- For the first two years cleaning is carried out by technical staff who have been authorised by ECOWOOD.
- The guarantee is not applicable for damage caused by: weather conditions, chemicals, electro-chemicals, fire, negligence or improper use, failure to observe the legislation in force, faults in the electrical system, lack of maintenance, tampering with the product, an inefficient chimney, the use of unsuitable fuel; the guarantee will this expire.
- THE GUARANTEE DOES NOT COVER: the pellet loading auger gearbox, the ignition resistance, the glass and painted parts.
- Other failures due to even partial lack of maintenance or incorrect installation.
- The guarantee does not cover damage caused by transport. It is therefore important to check the goods carefully on receipt and notify the retailer immediately if any damage is detected.
- The manufacturer will not be liable for compensation for direct or indirect damage caused by or depending on the product.

GUARANTEE - ECOWOOD - Via Borgo, 36 - MALO (VI) ITALY

Owner

Address Nr. Tel.....

Postcode Town State.....

Model Date Of Installation

Retailer Installer

Stamp Stamp.....

IMPORTANT

The user hereby declares that he/she has received the Installation, User's and Maintenance Handbook supplied with the stove, and will therefore use the stove as indicated in the handbook itself.

The user also declares that he/she has received all necessary explanations from the sales staff or from the technician at the time of installation.

N.B. The guarantee does not cover parts subject to wear, such as gaskets and seals, glass, pellet ignition resistance, grate, damage caused by electrical discharge or by poor maintenance of the stove.

Date

User's signature